



User manual

Silent Tools™ Plus Charger 1.0 A



Version 1.1

© 2020 Sandvik Coromant AB. All rights reserved. This document may not be copied or reproduced in whole or in part, or transferred to any other media or language, by any means, without the prior written permission of Sandvik Coromant AB.

Introduction

Purchase

Congratulations on your purchase of a Silent Tools™ Plus Charger and the use of Silent Tools™ Plus.

This manual contains important safety directions and instructions for product setup and operation.

Keep for further reference

Product identification

Product type and article numbers are printed on the product. Refer to this when contacting Sandvik Coromant.

Validity of this manual

This manual applies to the ST+: Charger 1.0-A, 161929.
Spare part No. 7120 110-01

Available documents

Silent Tools™ Plus Charger 1.0 A user manual and other documents can be downloaded from the Sandvik Coromant website:

<http://www.sandvik.coromant.com>

Content

1	Safety	1
1.1	General	1
1.2	Purpose	3
1.3	Hazard of use	5
1.4	Disposal	6
2	Description of the system.....	7
2.1	Main components	8
3	Operation	10
3.1	Start up	10
3.2	Inserting and removing battery	11
3.3	Charging the battery	12
3.4	Function lights	12
4	Care and transport	14
4.1	Transport	14
4.2	Storage	14
4.3	Cleaning and drying	14
5	Conformity	15
5.1	Simplified EU Declaration of conformity	15
5.2	Simplified sDoC, USA	16
5.3	Canada	17
5.4	Japan	17

6	Labels.....	18
7	Warranty	19
8	Technical data	20

1 Safety

1.1 General

Description

The following instructions should enable the person responsible for the product and the person who actually uses the equipment to anticipate and avoid operational hazards. The person responsible for the product must ensure that all users understand these instructions and adhere to them.

About warning messages

Warning messages are an essential part of product safety. They appear wherever hazards or hazardous situations can occur. For user safety, all safety instructions and safety messages shall be strictly observed and followed. Therefore, the manual must always be available to all product users.

DANGER, WARNING, CAUTION and NOTICE are standardized signal words for identifying levels of hazards and risks related to personal injury and property damage. For your safety it is important to read and fully understand the table below with the different signal words and their definitions. Supplementary safety information symbols may be placed within a warning message as well as supplementary information.

 **DANGER**

Indicates an imminently hazardous situation which, if not avoided, will result in death or serious injury.

 **WARNING**

Indicates a potentially hazardous situation or an unintended use which, if not avoided, could result in death or serious injury.

 **CAUTION**

Indicates a potentially hazardous situation or an unintended use which, if not avoided, may result in minor or moderate injury.

NOTICE

Important information which must be adhered to in practice as it enables the product to be used in a technically correct and efficient manner.

1.2 Purpose

Permitted use

Charging Silent Tools™ Plus battery.

Adverse use

- Use of the product without instruction.
- Use outside of the intended limits.
- Disabling safety systems.
- Removal of hazard notices.
- Opening the product using tools, e.g. screwdriver.
- Modification or conversion of the product.
- Use after misappropriation.
- Use of products with obviously recognizable damages or defects.
- Use with accessories from other manufacturers without the prior explicit approval of Sandvik Coromant.

WARNING

Adverse use can lead to injury, malfunction and damage. It is the task of the person responsible for the equipment to inform the user about hazards and how to counteract them. The product is not to be operated until the user has been instructed on how to work with it.

Manufacturer of the product

Sandvik Coromant is responsible for supplying the product, including the user manual and original accessories, in a completely safe condition.

Manufacturers of non-Sandvik Coromant Accessories

The manufacturers of non-Sandvik Coromant accessories are responsible for developing, implementing and communicating safety concepts for their products, and are also responsible for the effectiveness of those safety concepts in combination with the Sandvik Coromant product.

Person in charge of the product

NOTICE

The person in charge of the product has the following duties:

- To understand the safety instructions on the product and the instructions in the user manual.
- To be familiar with local regulations relating to safety and accident prevention.
- To inform Sandvik Coromant immediately if the product becomes unsafe.

1.3 Hazard of use

CAUTION

The product is not designed for use under wet and severe conditions. If unit becomes wet it may result in electric shock.

Precautions: Use the product only in dry environments, for example in buildings. Protect the product against humidity. If the product becomes humid, it must not be used!

WARNING

Batteries not recommended by Sandvik Coromant may be damaged if charged. They may burn and explode.

Precautions: Only charge batteries recommended by Sandvik Coromant.

CAUTION

Adapter safety. Use only the Sandvik Coromant supplied AC adapter approved for use with this device. Use of another AC adapter may increase the risk of fire or explosion.

NOTICE

Should an operational error or unexpected change in the performance occur during use; disconnect the product from the mains immediately by disconnecting the mains plug from the mains socket and contact the supplier.

NOTICE

Avoid sudden ambient temperature changes while charging the battery (e.g. do not let the sun shine directly on the battery or the charger). Sudden ambient temperature changes may cause the charging process to end prematurely without having fully charged the battery.

1.4 Disposal

Dispose of the product appropriately in accordance with the national regulations in force in your country.



At the end of their service life electric and electronic equipment and their accessories shall not be discarded with the municipal waste but be disposed of using separate collection, treatment, recovery/ recycling and environmentally sound disposal.

Precautions: Product specific treatment and waste management information can be downloaded from the Sandvik Coromant home page at www.sandvik.coromant.com/services or received from your Sandvik Coromant dealer.

2 Description of the system

Silent Tools™ Plus Charger 1.0 A is an intelligent charger. It is designed to charge the Silent Tools™ Plus specific battery. As power supply, main power shall be used. The charger has the following features:

- Constant current/constant voltage (CC/CV)
- Operation with thermal regulation
- Automatic end-of-charge control
- Safety timer 6 h
- 0.1C preconditioning for deeply depleted cells
- Battery cell temperature monitor

General information

One battery can be connected to the charger and charged.

The product is "switched on" by inserting the mains plug into the mains socket and "switched off" by disconnecting the mains plug from the mains socket.

When not in use please think about disconnecting the product from the mains. This will reduce the risk of hazards, reduce the products environmental impact and save electricity costs.

2.1 Main components

Available models

Silent Tools™ Plus Charger 1.0 A

AC/DC wall adaptor:

- GPE018A, 7110 010-02
- Mascot 3326, 7110 010-01

NOTICE

The charger is designed to recharge one original Silent Tools Plus A battery.

Component	Description
1. User manual	
2. Li-ion charger	Charger for Silent Tools™ Plus A Li-ion battery
3. Power	AC/DC power
4. Adapter plug	EU plug
5. Adapter plug	US plug (two items)
6. Adapter plug	UK plug

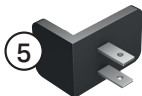
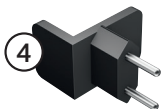

3 Operation

3.1 Start up

1. Connect your required adapter plug (EU/UK/US) on the AC/DC power.
2. Set the charger on a firm surface.
3. Connect the AC/DC power to the charger.
4. Connect the AC/DC power to the main power socket.

NOTICE

Pull the plug from the main socket if the charger will not be used for a long period.

Function check

When the AC/DC power is connected to the main power supply, the power LED at the DC power plug turns green. The function lights on the front of the charger will indicate status when a battery is inserted. Refer to section "3.4 Function lights" for additional information.

3.2 Inserting and removing battery

Inserting

1. Insert the battery (2) into the charger (1). Make sure to match the orientation pin with the charger slot.
2. A soft click indicates when assembly is complete.

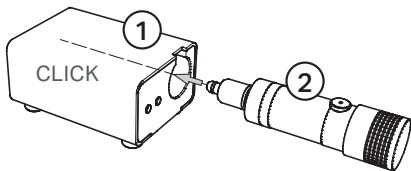

Removing

1. Hold the main body of the charger (1).
2. Hold the cylindrical end of the battery (2) and pull out gently.

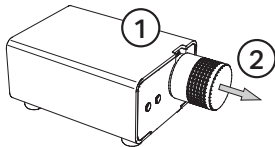











3.3 Charging the battery

1. Connect the Li-ion charger to the power supply. The power LED at the DC power plug turns green.
2. Insert the battery.
3. A red function light indicates the battery is being charged. Charging is done in three steps: precondition, constant current and constant voltage.

The battery may be removed or remain connected to ensure it is fully charged when needed.

3.4 Function lights

Symbol	LED	Meaning	
	Off	The charger is not connected to the power supply.	
	On	The charger is connected to the power supply.	
Charging	Done		
		Off/off	The battery is not present.
		Red/off	The battery is being charged.
		Off/green	The battery is fully charged.
		Red/green	A fault has been detected, refer to section "Error description".

Error description

In case of fault, both function lights turn on to indicate a fault in the charger and battery system.

If the charger indicates a fault when the battery is connected:

- The internal timer for maximum charging time might be reached. The charger stop charging after 6 ± 1 hours.
- Temperature in the charger may be too high for safe charging of Li-ion battery. At temperatures above 45°C , the charger will automatically shut off.

In case of battery not charging, please also check:

- If there is power coming from the main supply.
- If the cables are all correctly connected and no obvious faults can be detected.
- Connect a different battery to check if the fault lies with the battery or the charger.
- Battery may be defective.
- If the problem persists, contact Sandvik Coromant.

4 Care and transport

4.1 Transport

When transporting the product by rail, air or sea, always use the complete original Silent Tools™ Plus packaging, transport container and cardboard box, or its equivalent, to protect against shock and vibration.

Batteries must be removed before any transport. If battery is shipped with the product, a dangerous goods warning label and shipping information must be complied to.

4.2 Storage

Respect the temperature limits when storing the product, particularly in summer if the product is inside a vehicle. Refer to section "8 Technical data" for information about temperature limits and packaging to be used for safe storage.

4.3 Cleaning and drying

Use only a clean, soft, lint-free cloth for cleaning. Keep battery poles and power plugs clean and dry. Blow away any dirt lodged in the plugs of the connecting cables.

5 Conformity

5.1 Simplified EU Declaration of conformity

Sandvik Coromant AB, declares that the product Silent Tools™ Plus Charger 1.0 A is in compliance with the following directives and standards.

Following the provisions of EU-directives:	2014/35/EU (low voltage) 2014/30/EU (EMC) 2015/863/EU (RoHS3)
Safety:	EN 62368-1
Electromagnetical Compability (EMC):	EN 61000-6-2 EN 61000-6-4
RoHS:	EN 50581

For more information, see Declaration of conformity.

5.2 Simplified sDoC, USA

FCC Compliance statement

This product has been tested and found to comply with the limits for a Class B digital device, pursuant to part 15 of the FCC rules. These limits are designed to provide reasonable protection against harmful interference in a residential installation. This equipment generates, uses and can radiate frequency energy and, if not installed and used in accordance with the instructions, may cause harmful interference to radio communications.

However, there is no guarantee that interference will not occur in a particular installation.

If this equipment does cause harmful interference to radio or television reception, which can be determined by turning the equipment off and on, the user is encouraged to try to eliminate the interference by one or more of the following measures:

- Reorient or relocate the receiving antenna.
- Increase the separation between the equipment and the receiver.
- Connect the equipment to an outlet on a circuit different from that to which the receiver is connected.
- Consult the dealer or an experienced radio/TV technician for help.

Safety compliance to: UL 62368-1

5.3 Canada

This product complies to ICES-003, Issue 6, CAN ICES-3 (A)/NMB-3(A).

Safety compliance to: CSA C22.2 No. 62368-1

5.4 Japan

This is a VCCI compliant product, VCCI V-3.

Safety compliance to: J60950-1(H29) and IEC 60950

6 Labels

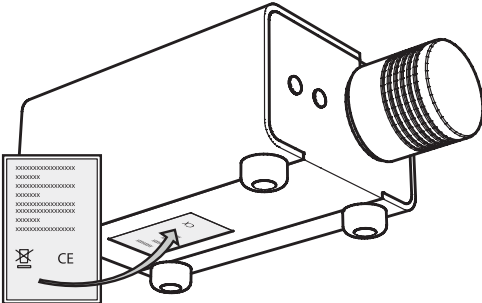

7 Warranty

Sandvik Coromant AB warrants its equipment for a limited period of two years, from purchase date, provided that it is installed exactly as defined in associated Sandvik Coromant documentation.

Failure to comply with this will invalidate the Sandvik Coromant warranty. Claims under warranty must be made from authorized service/sales personnel from Sandvik Coromant only.

8 Technical data

Power supply

Main connection ~ DC voltage connection

Input voltage	100–240 VAC, 50/60 Hz (EU, US, UK plug)
Output	7.5V DC, maximum 2.0 A
Power rating	Output maximum power 15 W
Temperature range	Storage: -25°C to +85°C Operating: 0°C to +40°C
Weight	Approx. 200 g (packaging not included)

Charger

Input voltage	7.5V DC, 2.0 A
Battery type	Silent Tools™ Plus battery type A
Charging power	1.0 A fast charging current. Multiple stage Li-ion charging (constant current, constant voltage) Thermal regulation / shutdown of charging 45°C Timer for charging, maximum 6±1 hours
Operating environment	Only operate in dry environment, e.g.in buildings. IP20 according to IEC 60529
Temperature range	Storage: -40°C to +85°C Operating: 0°C to +45°C

Recharging times	Charging at 20 °C Li-ion 3.6V, 2600mAh 2.5 to 3 h Li-ion 3.6V, 3450mAh 3.5 to 4 h
Indication	Refer to section "3.4 Function lights"
Weight	Approx. 470 g (packaging not included)

Sandvik Coromant Type A li-ion battery has a safety circuit, that has a very small drain on the battery. Regular charging of battery is advised.

User manual Silent Tools™ Plus Charger 1.0 A
English
Part No: 92055
Version 1.1

AB Sandvik Coromant
Mossvägen 10
811 81 Sandviken
Sweden
www.sandvik.coromant.com/silenttoolsplus

January 2020 © Sandvik Coromant

